



# Stereoscopic 3D Digital Theater System

## Operator Manual (MI-2100)



All information contained in or disclosed by this document is confidential and propriety to masterImage Co., Ltd. (hereinafter referred to as masterImage). By accepting this material, the recipient agrees that this material and information contained herein will be held in confidence and will not be reproduced in whole or in part, without the prior expressly written permission of masterImage Co., Ltd.

Copyright © 2005–2008 masterImage Co., Ltd.  
All Rights Reserved

masterImage Co., Ltd. Proprietary  
All other trademarks and copyrights are the property of their respective owners.



masterImage Co., Ltd. (<http://www.masterimage.co.kr>)  
1F, Baeksong Bldg., 14-2, Nonhyeon-dong, Gangnam-gu  
Seoul 135-811, South Korea  
TEL.: 82-2-3447-2727  
FAX. : 82-2-3447-9445



Korea Digital Communications Corp. (<http://www.kdcorp.co.kr>)  
3<sup>rd</sup> ~ 6<sup>th</sup> Floor, Soul Metropolitan Facilities Management Corporation  
Bldg. 540, Cheonggyecheonno, Seongdong-gu,  
Seoul, 133-739, South Korea  
TEL. : 82-2-3459-0566  
FAX. : 82-2-3459-0589

Table of Contents

1. Introduction .....	4
1.1 Introduction.....	4
1.2 Features .....	4
1.3 Shipping Contents .....	6
2. Overview of Main Parts.....	7
2.1 Circular Polarized Rotary Filter.....	7
2.2 Filter Driving .....	7
2.3 Filter Height Adjustment .....	7
2.4 Control Panel .....	8
2.5 Power Safety.....	8
2.6 Moving Wheels.....	9
2.7 Power Source .....	9
3. Installation & Operation .....	10
3.1 Installation.....	10
3.2 Setting Projector .....	13
3.3 Starting 3D Film .....	14
3.4 Ending 3D Film .....	15
4. Others.....	16
4.1 White Light Source.....	16
4.2 Caution.....	16
4.3 Trouble-shooting.....	19
4.4 Maintenance and Repair .....	20
4.5 Customer Support Center .....	20

# 1. Introduction

## 1.1 Introduction



MI-2100 is a stereoscopic 3D digital theater system working with only single HD digital projector and it works with its own unique technology. A Circular polarized rotary filter and makes it possible to enjoy realistic high-quality stereoscopic 3D images and has succeed in being the first of its kind commercially available in Korea.

MI-2100 helps exhibitors to reduce the cost of building stereoscopic 3D digital theater systems in their theaters, and to improve their operating efficiency by upgrading its viewing angle, crosstalk, and brightness, and more.

MI-2100 is one of the best ways available to build a stereoscopic 3D digital system in your theater.

## 1.2 Features

### 1. Improving conformity of right and left image

Inconformity means that right and left image are not matched with each other. If this happens, it can cause an audience to suffer from eyestrain. Specially, even if this problem is minor, this problem could be one of the biggest problems with a large-scale system like a digital theater system.

However, MI-2100 operates with only one single HD digital projector. This settles this problem by conforming right and left images to almost one hundred percent (100%).

MI-2100 helps an audience to minimize eyestrain and enjoy realistic stereoscopic 3D films conveniently, just like seeing objects in the real world.

## **2. Improving Cross Talk**

The high-speed rotation of the Circular Polarized Rotary Filter of the MI-2100 make it possible to separate the left and right images in accordance with sync signal of left and right images projected from the projector.

MI-2100 has its own unique structure for compensating for the loss of a polarizing ratio in accordance with the variation of rotation angle. This unique structure can help stereoscopic 3D image for minimizing Crosstalk and making stereoscopic 3D images brighter than the old type.

## **3. Improving Viewing angle**

MI-2100 helps audiences enjoy brighter stereoscopic 3D images without ghosting by using its unique circular polarized rotary filter, instead of linear polarized filters, even if the audience move thier bodies left or right.

## **4. Increasing exhibitor's revenue**

Owing to the fact that the MI-2100 operates with only single HD digital projector, exhibitors considerably reduce their costs to build stereoscopic 3D digital theater systems. Exhibitors can accommodate two times bigger an audience than 2D digital theater systems. In addition, exhibitors can alternate the digital theater systems they use in accordance with the number of people in the audience.

## **5. Excellent Compatibility**

An operator can easily swap a 3D system to a 2D system by adjusting the circular polarized rotary filter location of MI-2100, for example when operator wants to change 3D images into 2D film, he or she can just lower the filter location, so as not to block the left and right images projected from projector.

## 6. Easy installation and operation

MI-2100 is a stand-alone type and can be installed easily in front of the projector lens, and is easily linked to the projector by means of connecting the sync signal connector. The usage of the Control Interface of the MI-2100 is intuitive and convenient, and the MI-2100 is easily moved and fixed on the installation site, owing to its fixing wheel lever.

### 1.3 Shipping Contents

---

- MI-2100
- Spare Filter
- Sync Cable
- Operator Manual
- Transformer (220V ~ 230V)
- Filter Protector Box
- Filter Cleaning Cloth

## 2. Overview of Main Parts

### 2.1 Circular Polarized Rotary Filter



Circular Polarized Rotary Filter Part consists of two parts – the left image and right image circular polarized rotary filter. This creates a brighter and more realistic constant stereoscopic 3D image by rotating the filter either in 48 (2,880 rpm) cycles, which consist of half right image frame, and half left image frame per second. In other words, 96 frames (48 frames for left image and 48 frames for right image) or 72 (4,320rpm) cycles per second – 144 frames (72 frames

for left image and 72 frames for right image). Circular Polarize Rotary Filter is protected by a safety cover owing to high-speed rotation.

\* Remarks: General personal computer is 60 cycles (3,600rpm), i.e. 120 frames per second.

### 2.2 Driving Part

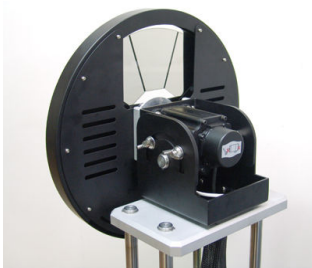

A motor drive makes circular polarized rotary filter rotate rapidly in accordance with the sync signals of left and right images projected from the Projector.

An excellent servo motor can make circular polarized rotary filter run with minimum noise and precise controls guarantee safety and reliance for the user.

Also, a circular polarized rotary filter can be adjusted to higher and lower angles, and level horizontal locations between the projector lens and the circular polarized rotary filter can also be adjusted.

### 2.3 Height Adjustment

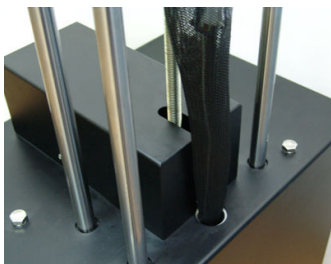

The height adjustment of the filter is controlled by the Control Panel. An operator can easily exchange a 3D system for a 2D system by adjusting the circular polarized rotary filter location of the MI-2100, i.e. when the operator wants to exchange 2D film into 3D, you can just lower filter location so as not to block the left and right images projected from projector.

If you want to go up or down circular polarized rotary filter location, press the “UP” button or “DOWN” button of 3D Filter Position on the

Control Panel. This function does not work while the system is in operation.

## 2.4 Control Panel



- ① AC POWER : POWR ON / OFF.
- ② EMERGENCY : stops operating system.
- ③ START/STOP : start or stop circular polarized rotary filter rotation.
- ④ WAIT : Wait (Red LED) is on right after circular polarized rotary filter rotation.
- ⑤ OK : OK (Green LED) is on after synchronizing the left and right images, The “Wait” (Red LED) will turn off at the same time.
- ⑥ PWR : When power is on, PWR (Red LED) is on
- ⑦ ALARM : When the user presses the emergency button or the motor controller has a problem, the Alarm (Red LED) will light up.  
\* ALARM Turing off : First, turn off the power and press the emergency button.
- ⑧ UP : Go up the circular polarized rotary filter part
- ⑨ DOWN : Go down the circular polarized rotary filter part.
- ⑩ SYNC IN : SYNC IN is connected to the GPIO port (port 1) of the Projector, which receives the left and right image sync signal from the projector



## 2.5 Power Safety

---

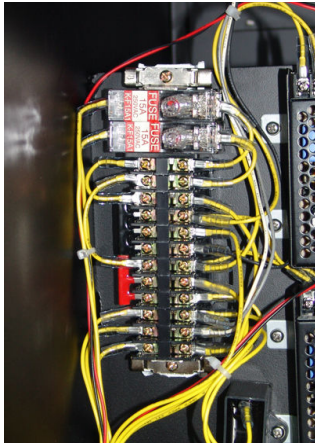

The breaker and fuse are installed for protecting from over-current in the inner body. If the fuse short circuits, the Red LED will turn on. In this situation, turn off the Red LED, turn off the power and contact the customer service technical center.

## 2.6 Moving Wheels

---



Moving wheels and a height adjustment lever are located on the bottom of the body. Level and fix the system to a suitable position.

## 2.7 Power

---



Connect plug to power source (220V).  
Check you have a ground connection.  
If the ground connection is not perfect, it will cause the system to fail.

## 3. Installation and Operation

### 3.1 Installation

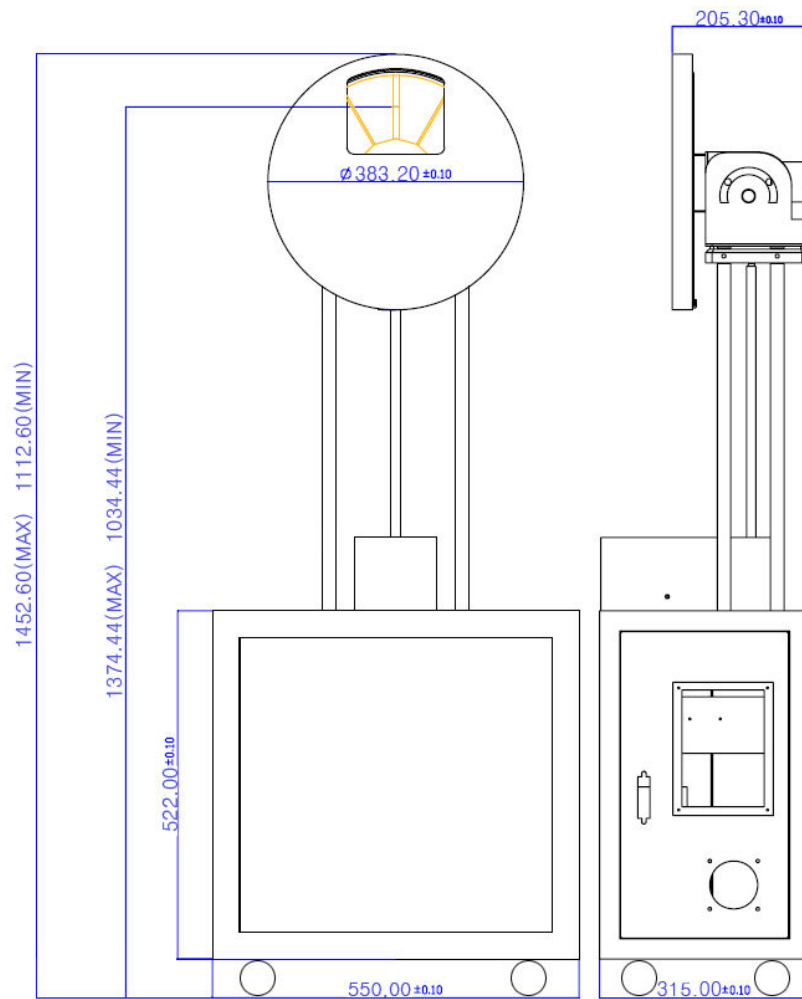

[Outer Drawing]

\* Caution before installation

Prepare the minimum space for installing the system between the Projector and Booth Porthole (the minimum space is 315mm).

Also, prepare the minimum space for the Filter Driving Part between the Projector lens and the Booth Porthole (the minimum space is 205.30mm)

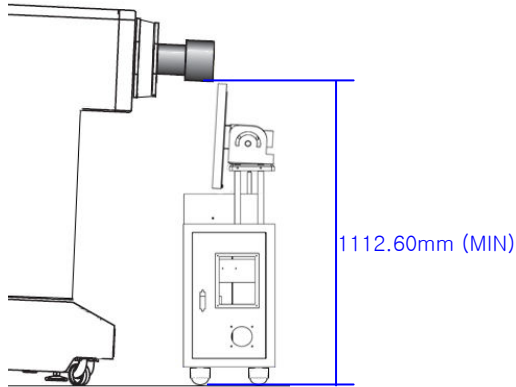

When a user wants to change a 3D system into a 2D system, the user has to lower the circular polarized rotary filter part so as not to block the left and right image projected from the projector. To do this, the user has to secure a minimum space (1,112.60mm) between the bottom of the Projector lens and the floor.

1. Move the system to the installation site.
2. Select a flat place and clear away obstacles.
3. The circular polarized rotary filter has to be installed closely and face toward the front of the Projector lens.
4. The Projector lens and Circular polarized rotary filter have to be paralleled both horizontally and vertically by adjusting both screws on the filter driving part and the direction of body. (Picture 3)
5. Check the location of the projected image on the Circular polarized rotary filter. (Caution: White light sources generate hot temperature, hot temperature damages to the circular polarized rotary filter.)
6. The projected left and right image from the projector should be exactly matched on the circular polarized rotary filter by adjusting both the height of the filter and location of the body. (Picture 1)
7. Align the joint of the circular polarized rotary filter at the edge of the side of left bottom of the projected image from the projector, locate and fix the sensor at the imaginary extension line of the joint of circular polarized rotary filter. (Picture 2)
8. Parallel the projector lens with the surface of circular polarized rotary filter both horizontally and vertically by adjusting both the direction of the body and the screws located on the circular polarized rotary filter driving part. (Picture 3)
9. Connect Sync cable to GPIO port (32 pin) of the projector, connect the Sync cable to Sync In (9 pin) on the Control panel.
10. Plug the power cable into the power source (220V).

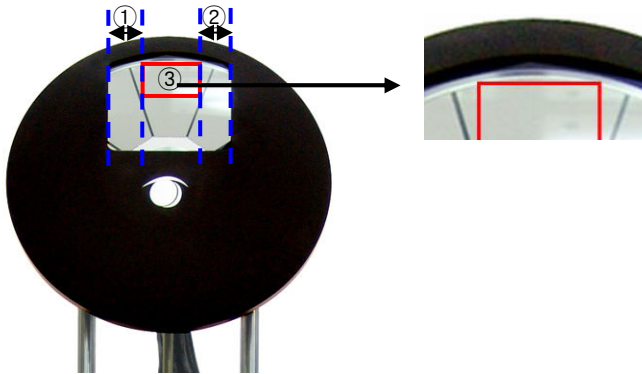

[Picture 1]

Correct location of the projected image on the circular polarized rotary filter

Do not go over the filter line.

- equalize the width of ① and ②.
- Align the projected image at the top of the filter to reach the surface of the circular polarized rotary filter.

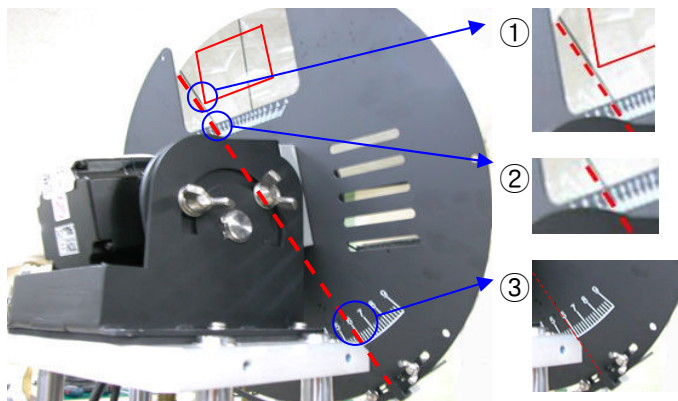

[Picture 2]

Correct location of Rotating Sensor

1. Align the imaginary extension line at the left bottom side of the projected image like picture ①.
2. Check the number of ② on the imaginary extension line.
3. Align the imaginary extension line and equalize the number of ② with the number of ③.

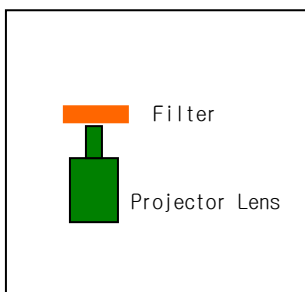

Top View

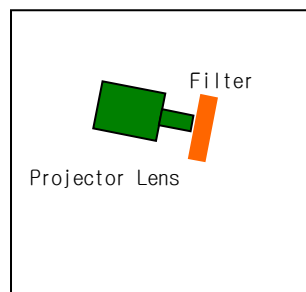

Side View

[Picture 3]

Correct installation of the circular polarized rotary filter and projector lens

Align the circular polarized rotary filter to the projector lens very closely.

Equalize the angle of both the projector lens and the circular polarized rotary filter by using the A screws shown in picture 4.



[Picture 4] If it is impossible to align the circular polarized rotary filter to the projector very closely owing to environmental restrictions of the installation site, use the B screws shown in picture 4. Loosen the B screws and move the filter to the projector lens very closely and tighten the B screws.

### 3.2 Setting Projector

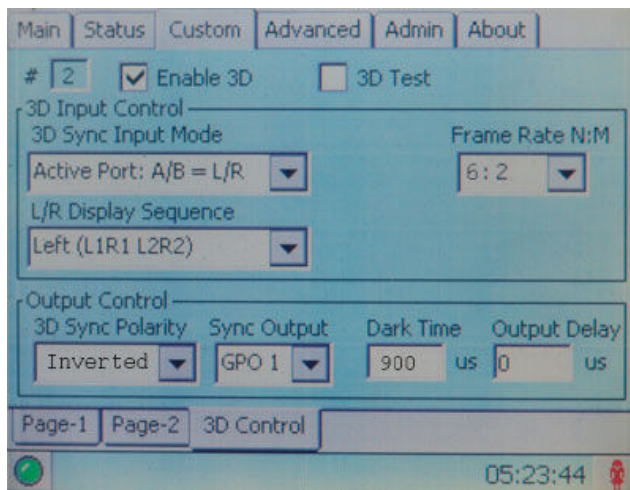

1. Connect HD projector to 3D Server and operate. (Please refer to the manual for more information.)

2. Upload the film, finish all the steps and be ready to push the “PLAY” button on the Server. (Projector is in the process of 3D Sync Signal Output)

3. Set up the 3D mode on the HD projector. (Projector manufacturer supplies manual – Picture 5)

\*\* Frame rate: 6:2 (144 frames)

\*\* Frame rate: 4:2 (96 frames)

– Christie CP 2000 [Picture 5]–

[Picture 5] HD Projector 3D Set-up Mode Display

- Dark Time depends on type of Projector and Server.
- 3D Sync Polarity depends on the settings of server and projector.

**3.3 Starting Film**

1. Set up the Server and Projector in waiting mode, which can start the 3D film on pushing the “Play” button.
2. Check the Sync cable connection.

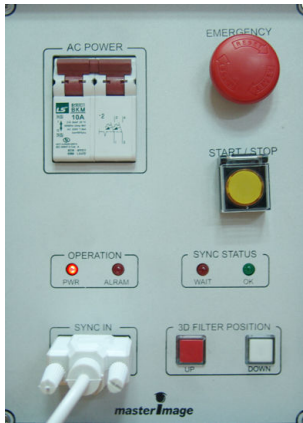

3. Turn on AC Power on the control panel by pushing the up lever.  
Red LED on AC Power is ON. If the sync signal (90fps, 120fps, 144fps) is not compatible with the system, WAIT LED will be flickering.

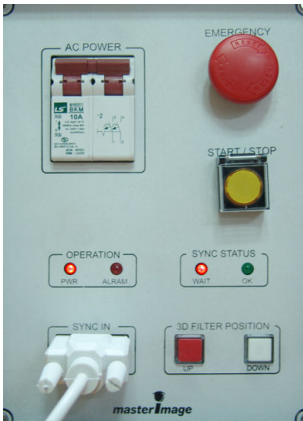

5. Push Start button. The circular polarized rotary filter starts rotating and WAIT LED button is ON.

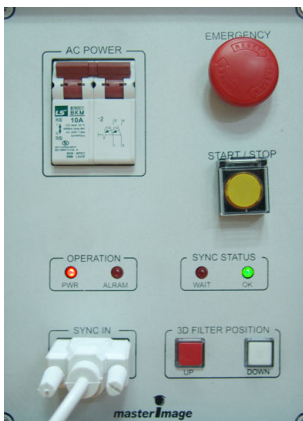

6. After finishing sync optimization for 5 to 6 seconds, OK Green LED is on and WAIT Red LED will automatically turn off.

7. Starting the 3D film by pushing the Play button on the Digital Server.

### 3.4 Ending Film

---

1. Push the STOP button. Circular polarized rotary filter stops rotating.
2. After rotation of filter stops completely, turn off AC Power by pushing down on the lever.
3. Ending operation of HD projector and 3D server.  
(Refer to the projector and server manual for more information.)

## 4. OTHERS

---

### 4.1 White Light Source

---

1. To rotate the circular polarized rotary filter, keep pushing the Start button for 5 to 6 seconds until the OK LED starts flickering.
2. After setting a White Light Source, stop operation by pushing the Start button.

### 4.2 Caution

---

1. Read the User's Manual carefully before operation.
2. When you move, repair, or disassemble the system, turn off the power first.
3. While system is operating, do not touch the circular polarized rotary filter, and stay away from the circular polarized rotary filter – the high speed rotation of the circular polarized rotary filter could cause bodily harm.
4. When you install the MI-2100 on your site, check the level and fix the machine tightly to prevent the machine from vibrating on operation. (Fix the machine by using the fixed wheel brake)
5. Circular the polarized rotary filter used in MI-2100 is very sensitive to heat. Check the temperature to make sure it does not exceed 60°C. (Specially, be careful to use this with the White Light source)
6. MI-2100 is very heavy and is manufactured to prevent system vibration. Please be careful when moving the MI-2100.
7. While you run the MI-2100 for a long time, the connection between the Motor and Rotary Filter may become loose. Please check the



connection regularly. (If the connection becomes loose, it will make a noise)

8. If you want to exchange the rotary filter because of damage, first, disassemble the safety cover of the circular polarized rotary filter. Second, loosen the screws located the center of circular polarized rotary filter and exchange the filter for a new filter and reassemble in reverse order. Circular polarized film attached to the side of the circular polarized rotary filter should face towards the screen. (Picture 5 & 6)
9. The MI-2100 is a precise system which is composed of intricate electronic parts. While operating this system, use it carefully in accordance with the User's Manual.
10. Do not disassemble or reassemble without permission of an authorized engineer.
11. If you do not use Projectors, Severs and 3D glasses recommended by masterImage, we can not guarantee the perfect performance of the system.
12. While the rotary filter starts running, rotating, ending, noise occurs because of its own part's character. However, it doesn't affect the system performance.



[Picture 5]  
After removing the safety cover of circular polarized rotary filter

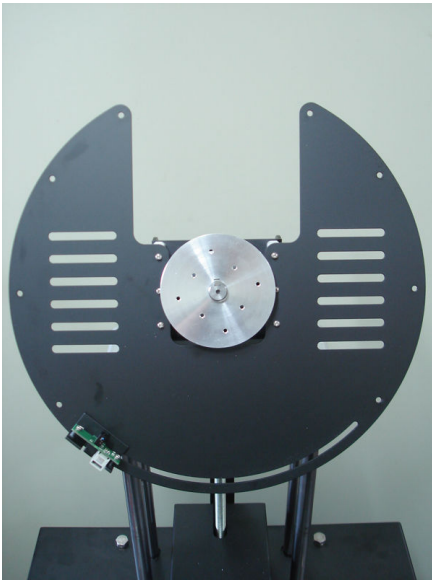

[Picture 6]  
After removing the circular polarized rotary filter.  
In case of exchanging the circular polarized rotary filter, please be careful that the Circular polarized film attached to the side of the circular polarized rotary filter is facing towards the screen.

### 4.3 Trouble-shooting

1. The Circular polarized rotary filter does not rotate  
(i.e. the Ready LED is flickering)
  - It seems that Sync signal from the Projector is not outputting correctly. Check the operation of Projector and 3D Server.
  - Turn off the power. Start again from the first step. (Refer to P. 10, installation & operation.)
  - Check the Sync Cable connection between the projector and the MI-2100.
  
2. The Circular Polarized Rotary filter rotates well, however, the Left and Right images projected from the projector do not seem to be separated well.
  - This phenomenon may happen in the process of detecting the output of the Sync signal from the projector, or when you run the MI-2100 in advance before Projector and 3D Server operates, or when you turn on the system directly after a compulsory end while the Circular polarized rotary filter is operating.  
(Power off or Emergency off)
  - Turn off the power. Start again from the first step.  
(Refer to the P. 10, installation & operation.)
  - The location of projected image on the circular polarized rotary filter may be mismatched. Check and adjust the alignment. (Picture 1)

If you don't use 3D glasses recommended by masterImage, we cannot guarantee perfect performance.
  
3. Noise increases gradually while the circular polarized rotary filter rotates.
  - This phenomenon happens when the connection between the Motor and Circular polarized rotary filter becomes loose. Please check the connection regularly.
  - While you operate the MI-2100 for a long time, the connection between Motor and Circular polarized rotary filter may become loose. Please check the connection

regularly.

4. OK Green LED turns on right after the power is turned on.
  - This phenomenon happens when the sensor does not work properly.  
If you encounter this problem after checking the screen, please call the Customer Support Center.

#### **4.4 Maintenance & Repair**

---

1. While operating the system for a long time, the screws may become loose. Regularly check the screws located on the back of the circular polarized rotary filter.
2. While system is not operating, please protect the circular polarized rotary filter with the filter cover contained in the shipping contents.
3. Particles cause damage to circular polarized rotary filter. Please clear particles using the cloths contained in the shipping contents.  
<Caution> Do not wash the circular polarized rotary filter with water.

#### **4.5 Customer Support Center**

---

Technical Support : [dyoung@masterimage.co.kr](mailto:dyoung@masterimage.co.kr)

Sales Support : [ljh1680@kdccorp.co.kr](mailto:ljh1680@kdccorp.co.kr)